



METERS



PUMPS



DISPENSERS



ACCESSORIES



AdBlue®



SOLUTIONS

PREVIEW CATALOGUE 2.0

MADE IN ITALY



Chi siamo - Who we are...



 Con oltre 30 anni di esperienza, a partire dai noti marchi italiani GASCO e KSK, Adam Pumps nasce nel 2010, a seguito del Management Buy-Out di Tuthill Italia Spa, Filiale italiana del gruppo americano Tuthill Corporation, leader mondiale nella produzione di pompe e contatori per benzina.

La parola chiave dell'Azienda è Qualità.

Qualità dei prodotti, interamente concepiti e progettati dai nostri responsabili tecnici attraverso le tecnologie più avanzate, nonché testati individualmente secondo i più severi standard qualitativi.

Tutta la produzione e l'assemblaggio avvengono presso il nostro stabilimento di Campogalliano nei pressi di Modena, per questo ogni prodotto Adam Pumps è 100% Made in Italy.

Qualità del servizio e totale soddisfazione del cliente. Il nostro processo produttivo segue le linee guida del cosiddetto "Lean Manufacturing", garantendone così la massima efficienza, mentre la filosofia del "Continuous Improvement" ci rende dinamici e sempre aperti alle richieste del cliente.



Adam Pumps was founded in 2010 following the management buy-out of Tuthill Italia Spa, the Italian branch of Tuthill Corporation, world leader manufacturer of pumps and meters for gasoline. Prior to Tuthill, the company, had long been a specialist for the diesel transfer solutions as GASCO and KSK, giving us over 30 years experience.

At Adam Pumps we focus on quality.

Quality of the products, all of which are conceived and designed at our technical department through the most accurate technology and individually tested according to the most stringent parameters.

Manufacturing and assembling are all carried out at our factory in Campogalliano which means our products are Made in Italy.

Quality of the service and complete customer's satisfaction. Our Lean Manufacturing protocol guarantees efficiency and fast response, our Continuous Improvement philosophy makes sure the customer's requirements are always met and fulfilled.





Mechanical

TECH FLOW 3C-4C



min 20

max 120

±1%

in-out 1"



Digital

IN LINE



milk
oil
water



PULSE-OUT VERSION AVAILABLE



AAA

min 10

max 150

±0.5

in-out 1"

Oval Gear

G - FLOW



AVAILABILE ALSO WITH PULSE OUT

AAA

min 10

max 120

±0.5

in-out 1"

display



IP55

Volt 12

G - FLOW Reed Switch

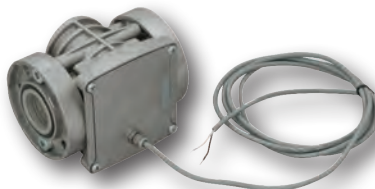



ELETTROPOMPE - ELECTRICPUMPS

O - TECH 40

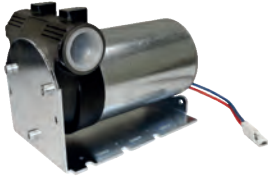

duty 30min in-out 3/4" l/min 40 Volt 12/24 Volt 230 vanes pump

AC TECH 40



DIFFERENT PLUGS AVAILABLE

IP55 duty 30min in-out 3/4" l/min 40 Volt 230 vanes pump

DC TECH 40



IP55 duty 30min in-out 3/4" l/min 40 Volt 12/24 vanes pump

PB 45 - PB1 45

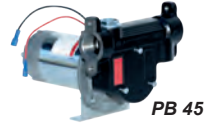

PB 45



PB1 45

IP55 vanes pump duty 30min in-out 1" l/min 45 Volt 12/24

PB - PB1

UP TO

l/min 85

PB



PB1



IP55 vanes pump duty 30min in-out 1" Volt 12/24



PA1 70

70
dB



DIFFERENT PLUGS AVAILABLE

IP55

conti-
nuous
duty

in-out
1"

l/min
70

Volt
230

vanes
pump

PA2 80



DIFFERENT PLUGS AVAILABLE

IP55

duty
30min

in-out
1"

l/min
80

Volt
230

vanes
pump

PA2 100



DIFFERENT PLUGS AVAILABLE

IP55

duty
30min

in-out
1"

l/min
100

Volt
230

vanes
pump

PA3 150



DIFFERENT PLUGS AVAILABLE

IP55

duty
30min

in-out
1"

l/min
150

Volt
230

vanes
pump

E 220



OLIO
OIL



SUITABLE FOR OIL UP TO 700cSt

IP55

duty
30min

in-out
3/4"

l/min
28

Volt
230



DISTRIBUTORI - DISPENSERS

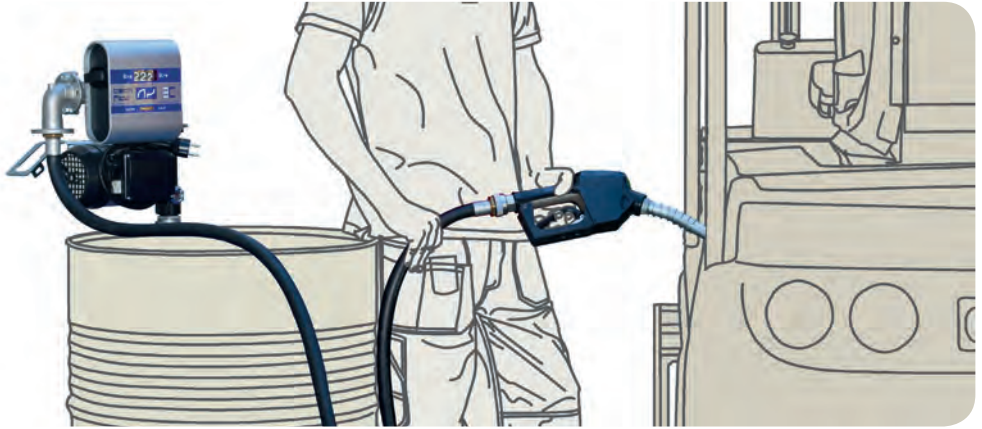

DRUM TECH 40



AUTOMATIC NOZZLE VERSION AVAILABLE

duty 30min | l/min 40 | Volt 12/24 | Volt 230

DRUM TECH



MANUAL NOZZLE VERSION AVAILABLE

l/min 60
l/min 80
l/min 100

duty 30min | pump PA | Volt 230

LIGHT TECH



MANUAL NOZZLE VERSION AVAILABLE

l/min 40
l/min 60
l/min 80
l/min 100

duty 30min | Volt 230 | Volt 12/24 | Delivery 4m

EASY TECH 40



AUTOMATIC NOZZLE VERSION AVAILABLE

duty 30min | l/min 40 | Volt 12/24 | Volt 230 | suction 2m | Delivery 4m



ARMADILLO



OPTIONAL

l/min
40

l/min
45

l/min
60

l/min
80

l/min
100

duty
30min

Volt
230

Volt
12/24

WALL TECH

l/min
40

l/min
45

l/min
60

l/min
80

l/min
100



AUTOMATIC NOZZLE VERSION AVAILABLE

duty
30min

Volt
230

Volt
12/24

HI TECH

l/min
60

l/min
80

l/min
100



MANUAL NOZZLE VERSION AVAILABLE

duty
30min

pump
PA

Volt
230



DISTRIBUTORI - DISPENSERS

AF3000 FMS



PC PROGRAM



- l/min 60
- l/min 70
- l/min 80
- l/min 100

- duty 30min
- pump PA
- Volt 230
- Users 999



AF3000



- l/min 60
- l/min 70
- l/min 80
- l/min 100



AUTO SWITCH OFF



OPTIONAL

- duty 30min
- pump PA
- Volt 230

PEDESTAL AF3000



mm 1007



MANUAL NOZZLE



Up to 100 l/min

AUTOMATIC NOZZLE



SWIVEL INCLUDED

l/min
60

l/min
90

l/min
120

l/min
280

SUCTION KIT



Open: 1030mm
Close: 590mm

3/4"

2"

3/4" - 1"

2m

3/4" - 1"

4m

DELIVERY KIT



MANUAL NOZZLE VERSION (PIT TECH) AVAILABLE

Ø
19

Ø
25

m
4

m
6

m
10

FITTINGS-FLANGES



HOSES & COILS



Ø
19
25

m
4-10

Ø
19
25

m
50-60



HOSE REEL Ø 19 - Ø 25 DIESEL



without hose

in-out
1"

m
10

m
15

m
20

HOSE REEL Ø 19 AdBlue®



without hose

in-out
3/4"

m
8



FILTERS WATER REMOVAL



l/min
100



l/min
90



l/min
60

OPT 10µm



µm
10

µm
25

FILTER



µm
10



l/min
100



BUNG ADAPTOR

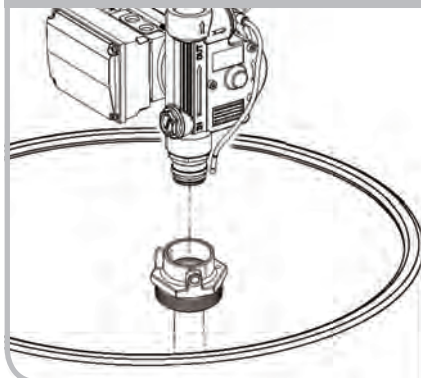

3/4"

1"

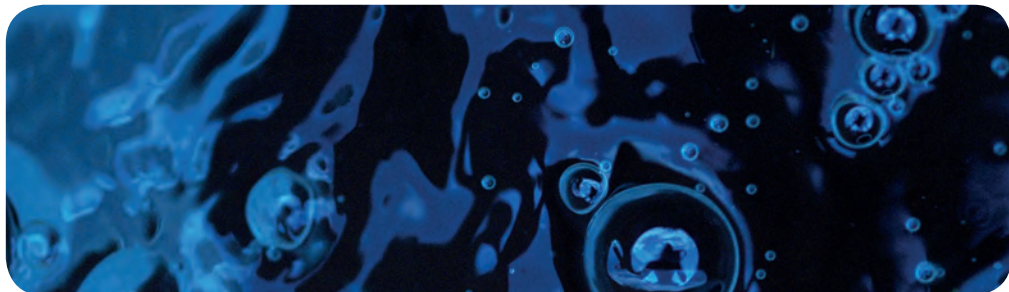
X BLUE 12V**DIAPHRAGM PUMP****IP55**duty
20_{min}in-out
3/4"l/min
40Volt
12**X BLUE 230V****DIAPHRAGM PUMP****IP55**duty
20_{min}in-out
3/4"l/min
40Volt
230**BLUE TECH 1****DELIVERY AND SUCTION HOSES INCLUDED**
MANUAL NOZZLE VERSION AVAILABLEl/min
40Volt
12Volt
230duty
20_{min}**BLUE TECH 2****DELIVERY AND SUCTION HOSES INCLUDED**l/min
40Volt
12Volt
230duty
20_{min}

TRANSFER KIT - X BLUE



l/min **40**
Volt **12**
Volt **230**
duty **20min**

IBC KIT



Ø **19**
m **8**

S60x6 KIT



Ø **19**
m **8**

BOTTOM VALVE KIT



Ø **19**
m **8**

IN LINE



PULSE-OUT VERSION AVAILABLE



AAA
min **10**
max **150**
% **±0.5**
in-out **1"**

AD BLUE® NOZZLES



X BLUE TROLLEY**BASIC VERSION**

with manual nozzle

**PRO VERSION**with flowmeter and
automatic nozzle**OPTIONAL**upon request
telescopic hose
for tankl/min
40Volt
12Volt
230duty
20
min**BLUE TECH FMS-P**duty
20
minl/min
40Volt
12Volt
230Users
250



FMS

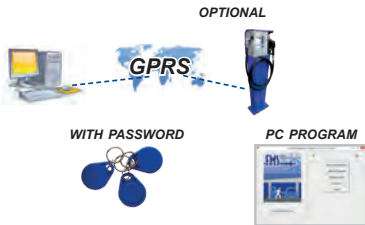

IP55



Users 999



DATA DOWNLOAD KIT (FMS)



FMS - P



Users 250

12V

min 10

max 150

% ± 0.5

in-out 1"

G FLOW TAG



min 10

max 120

% ± 0.5

in-out 1"

display

IP55

Users 250



MADE IN ITALY



ADAM PUMPS S.p.A.
Via delle Resistenza 46, 48
41011 Campogalliano (MO) ITALIA
Tel. +39 059 528128 Fax + 39 059 528437

www.adampumps.com - info@adampumps.com

